



# MODEL GENERATION TECHNICAL REPORT

## Generation of mouse model : Mir137 conditional Knock-Out

Project code: G17 / IR3731

Report updated: 07/09/2023

1 PROJECT PROCESS &  
QUALITY CONTROLS

2 GENETIC STRATEGY

3 HOMOLOGOUS RECOMBINATION  
VECTOR CONSTRUCTION

4 ES ELECTROPORATION & SCREENING OF  
RECOMBINANT CLONES

5 MICROINJECTION & BREEDING

6 SEQUENCE OF THE DELIVERED ALLELE

# PROJECT PROCESS & QUALITY CONTROLS

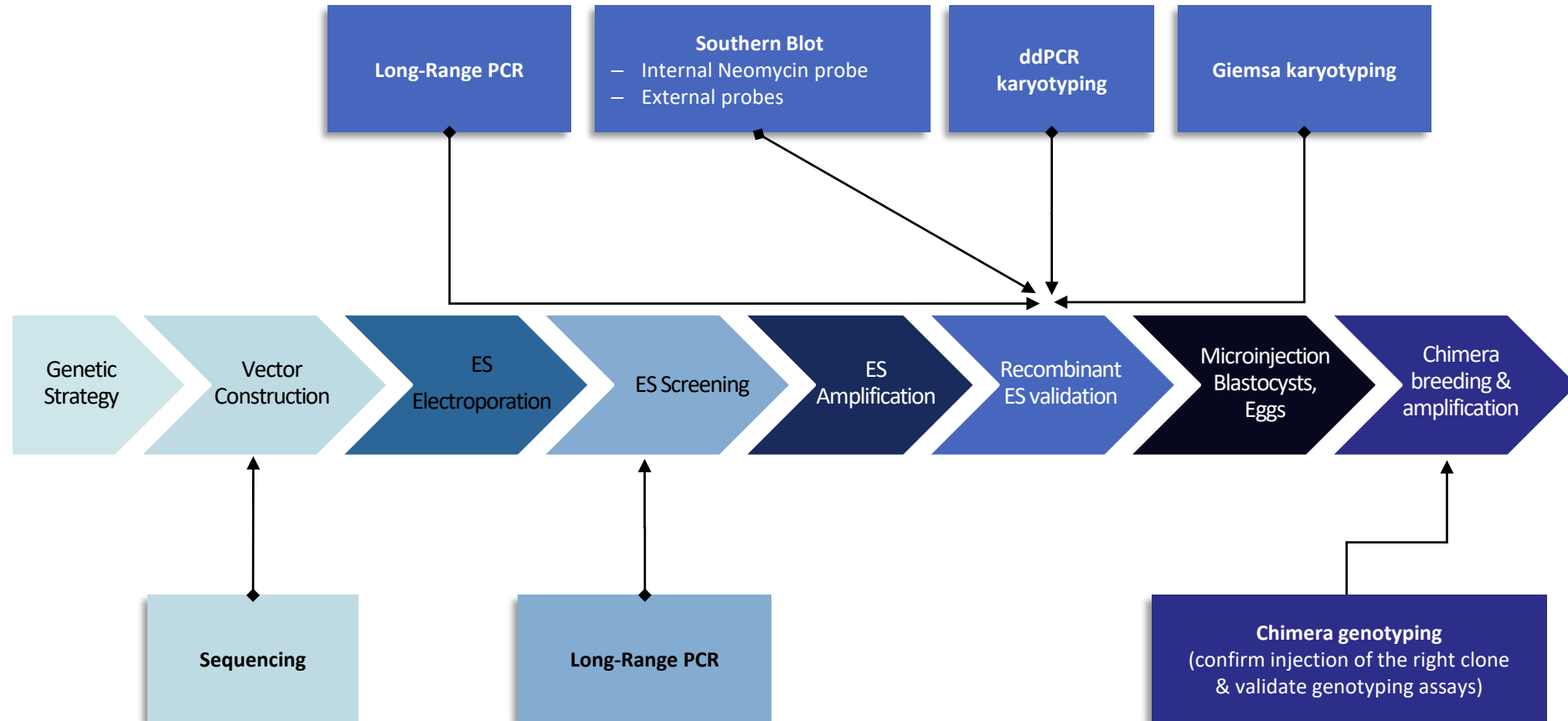

## 2 GENETIC STRATEGY

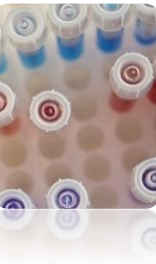

- Target locus structure
- mRNA(s) and protein(s)
- Genetic strategy
- PRO & CONS evaluation of the strategy

# Human MIR-137 genomic locus – structure



## Chromosome 1: 98,042,735-98,049,518

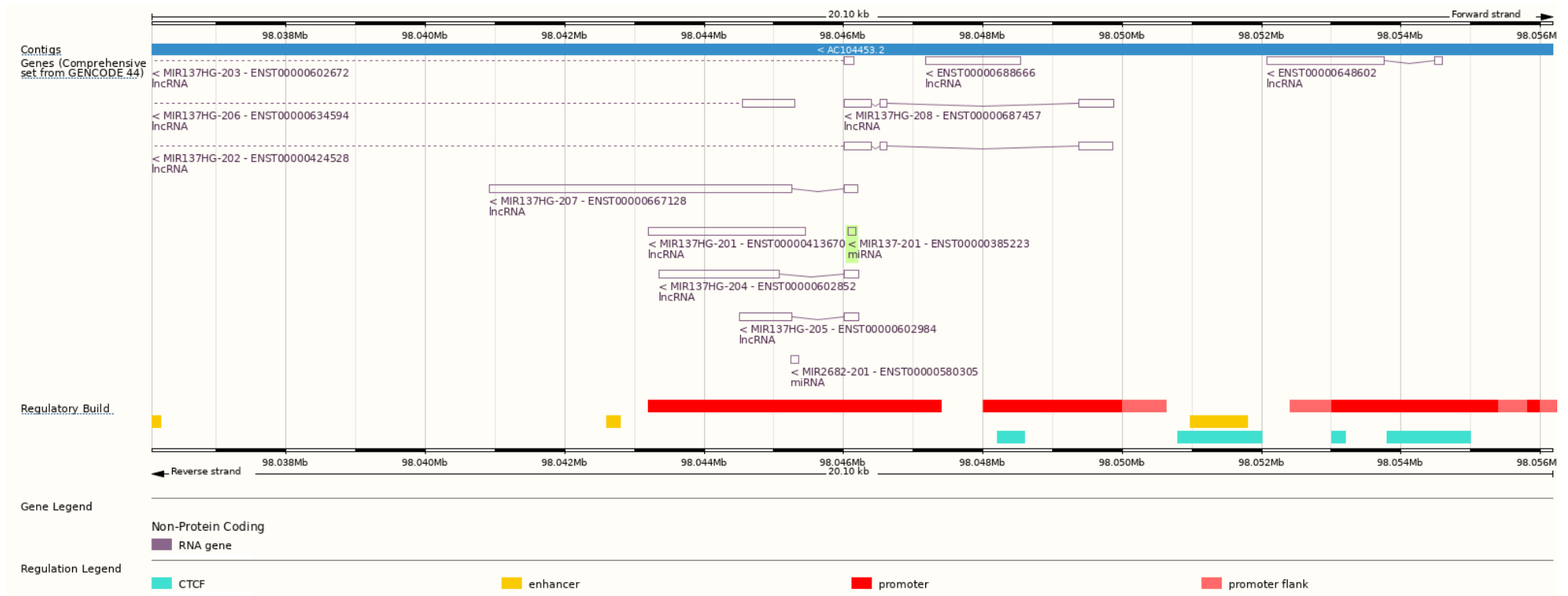
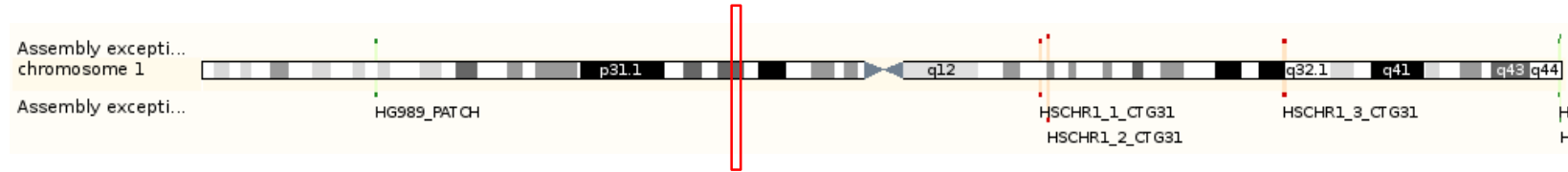

# Mir-137 mouse genomic locus – structure



Chromosome 3: 118,227,506-118,227,578

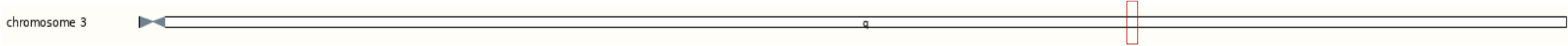

Gene: Mir137 ENSMUSG00000065569

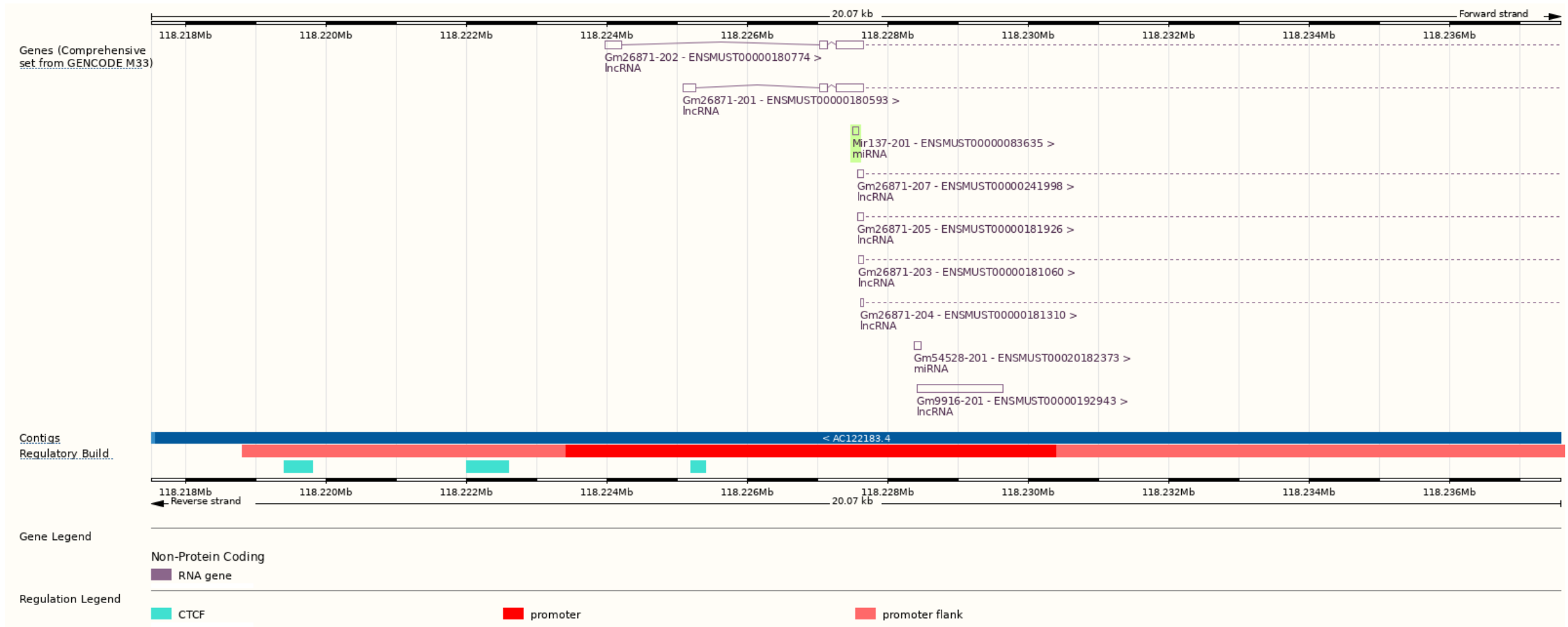

## ■ Mir137 mRNA and protein



Transcript ID	Name	bp	Protein	Biotype	CCDS
<a href="#">ENSMUST00000083635.4</a>	Mir137-201	73	No protein	miRNA	

# ■ Strategy

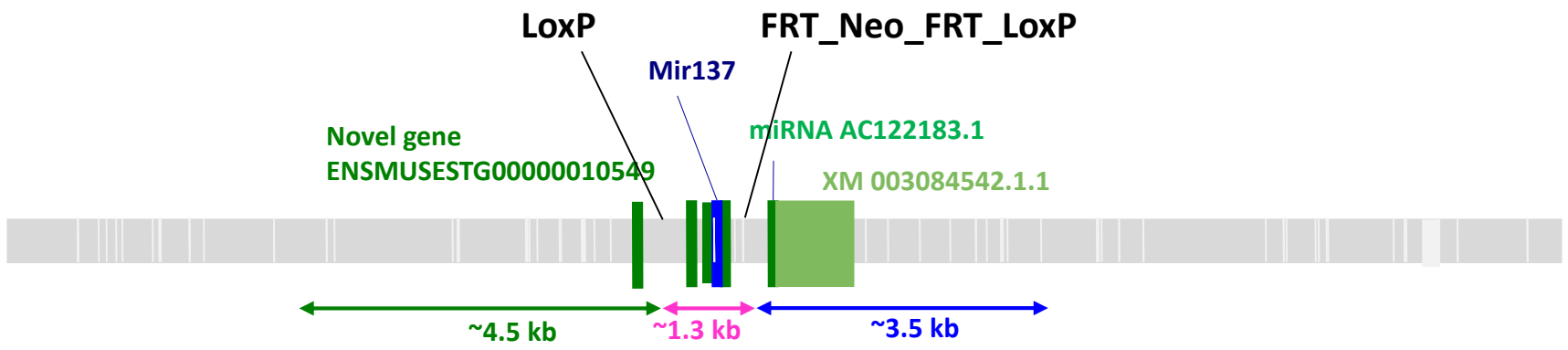

□ Repeated regions



## ■ PROs& CONs evaluation of the strategy

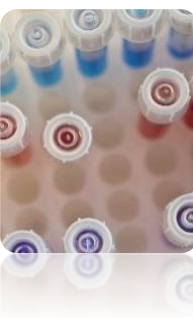

### Pros

- miR137 will be deleted after Cre mediated excision

### Cons

- *Other putative genes (EST and microRNA) might be disturbed before and after Cre mediated excision. These new genes have recently be described in mouse*

The selection cassette (FRT-Neo-FRT) will be removed by breeding male chimera with a flp deleter line which shows maternal contribution (*Birling et al., 2012*)

**Highly-efficient, fluorescent, locus directed cre and FlpO deleter mice on a pure C57BL/6N genetic background.**

Birling MC, Dierich A, Jacquot S, Hérault Y, Pavlovic G. *Genesis*. 2012 Jun;50(6):482-9. doi: 10.1002/dvg.20826.

# 3 HOMOLOGOUS RECOMBINATION - VECTOR CONSTRUCTION



Created by SnapGene

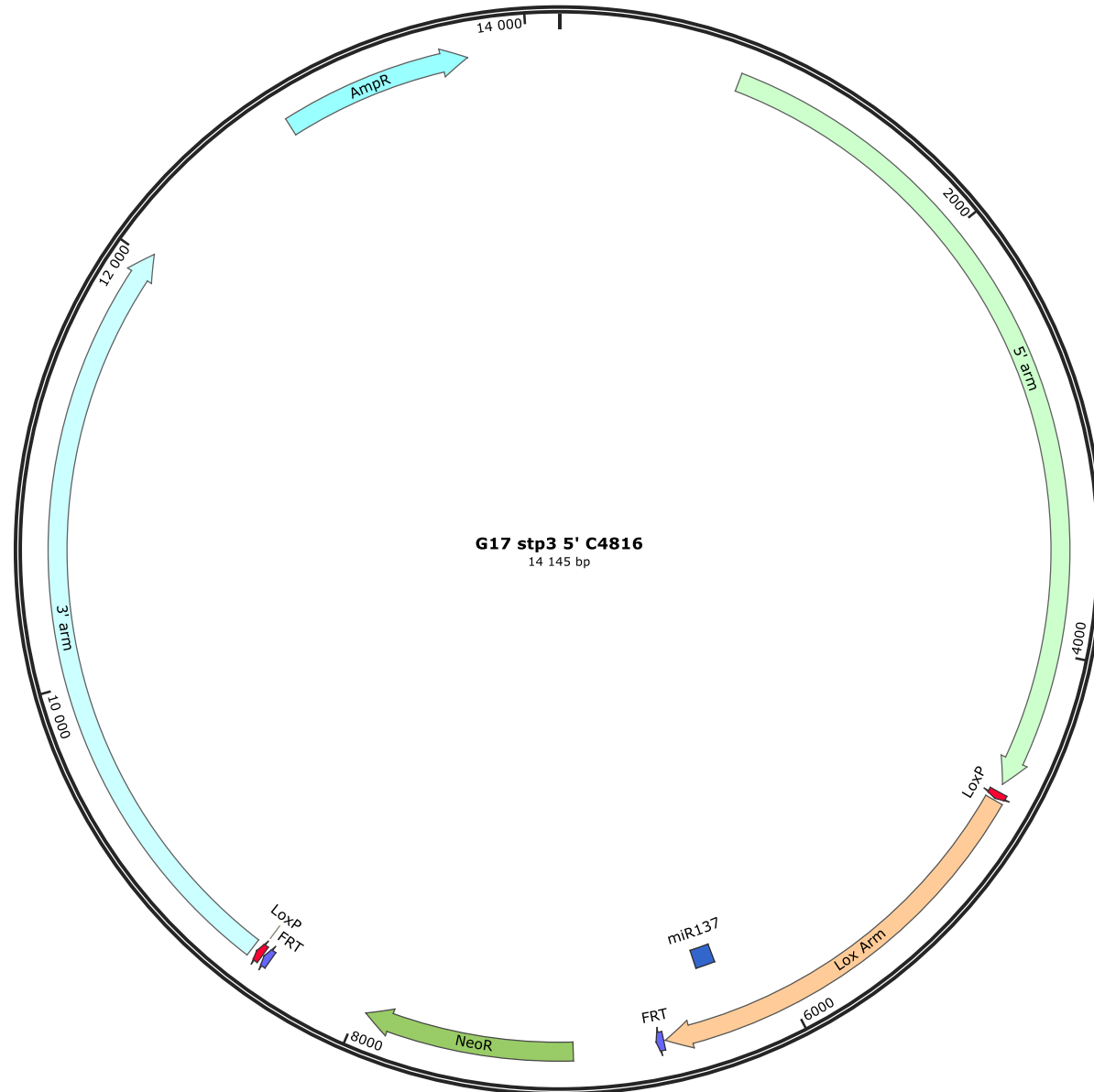

## 4 ES cell electroporation & Screening of recombinant clones

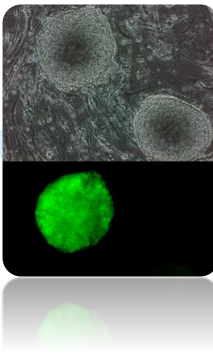

- Electroporation and screening process
- Long range PCR screening – strategy
- Long-Range 5' PCR screening – results
- Recombinant ES validation by Long Range PCR
- Recombinant ES clones validation by Southern Blot – internal probe
- Recombinant ES clones validation by Southern Blot – External probe
- Aneuploidy screening in ES recombinant clones

## ■ Electroporation and screening process

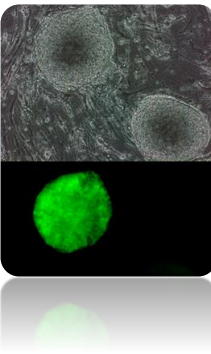

The targeting vector was electroporated in the proprietary C57BL/6N BD10 cell line.

Transfected ES clones were submitted to neomycin selection (G418) and 104 resistant ES clones were isolated. The clones were then submitted to the screening process allowing secured identification of those harbouring the expected recombination events at both ends of targeting vector.

Screening process steps:

1. Identification of candidate recombinant clones by initial 5' Long-Range PCR
2. Seven of 5' PCR positive clones are confirmed for 3' recombination event by Long-Range PCR
3. Positive clones in step2 are further validated by Southern blot analysis using internal probe
4. The karyotype of at least 2 validated clones is verified using ddPCR aneuploidy screening and Giemsa staining

# Long range PCR screening – strategy

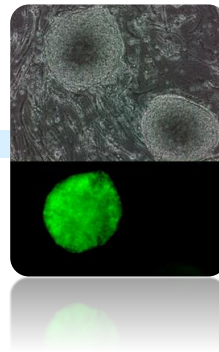

## Schematic 5' and 3' PCR screening strategy

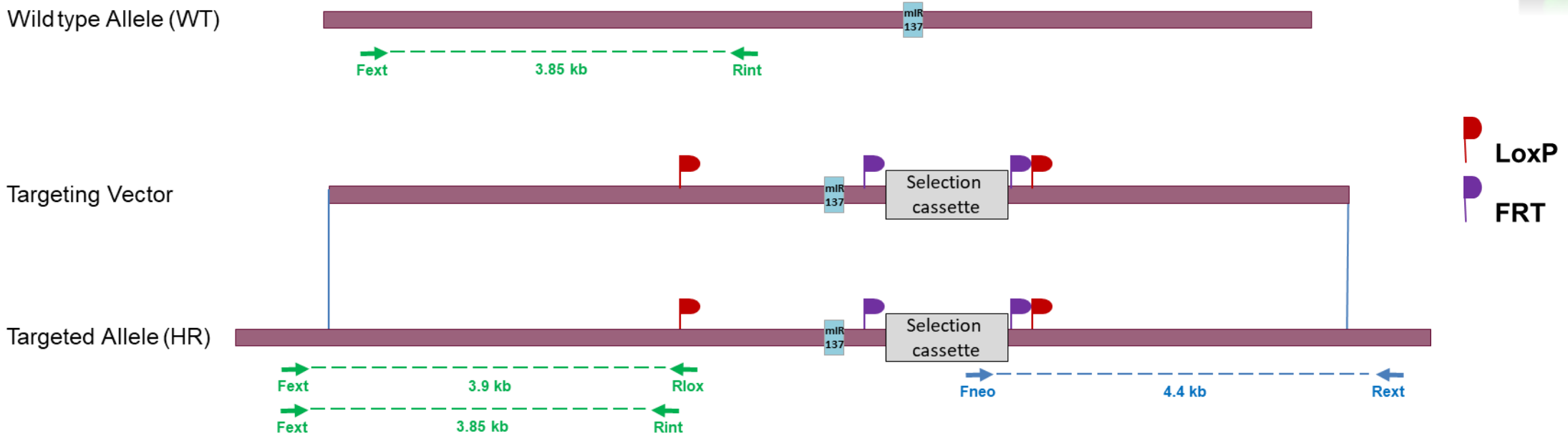

PCR	Primer Name	Primer sequences	PCR product size
5' PCR	Fext	AGGACAGACAGTGTGAGTGCACC	3.9 kb
	Rlox	GTTATCTGCAGGTCGACCTTAAGCT	
5' PCR	Fext	AGGACAGACAGTGTGAGTGCACC	3.85 kb
	Rint	CCTATCTTTGCAGTTATCTTTTTAG	
3' PCR	Fneo	AGGGGCTCGCGCCAGCCGAAGTGT	4.4 kb
	Rext	CAAAGATGGCTACAGCAGTTTAGTG	

# Long-Range 5' PCR screening – results

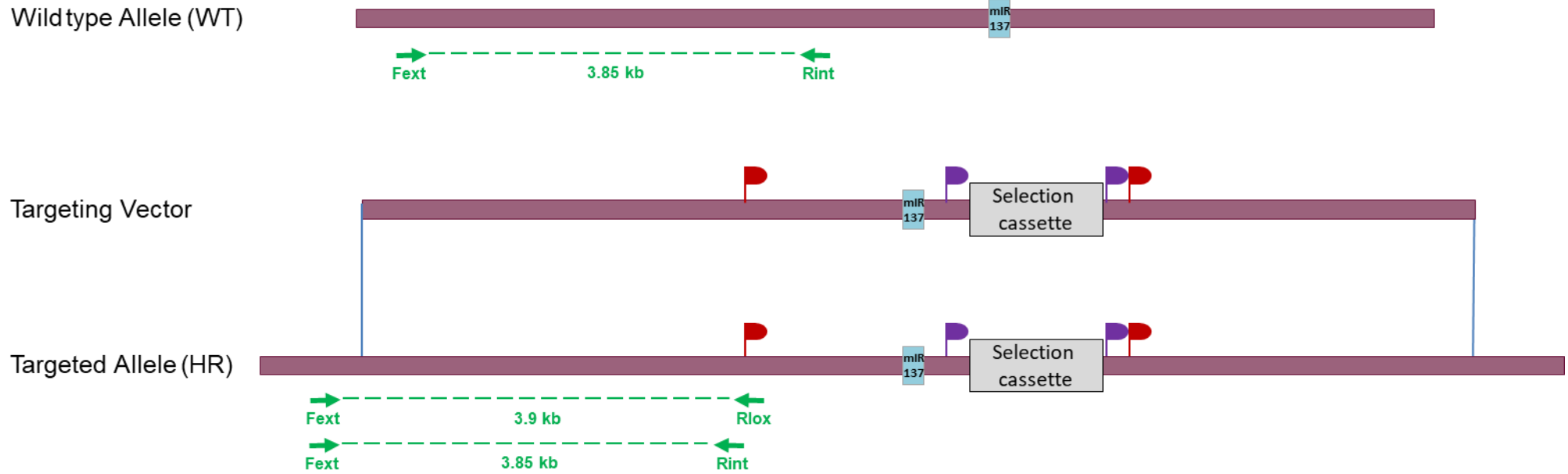
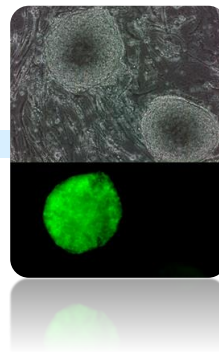

LoxP  
FRT

PCR Fext – RLox : 3.9 kb

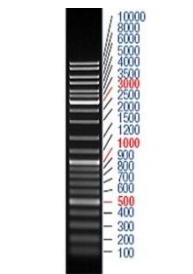
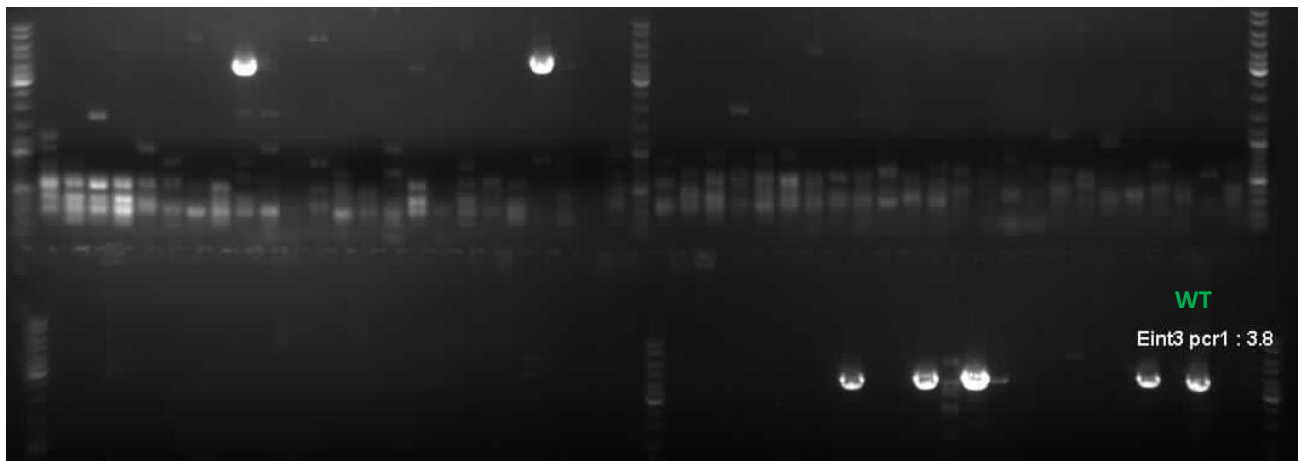

Ladder pattern

WT : Controls DNA

PCR Fext – Rint : 3.85 kb

Seven candidate clones out of the 7 positive clones were selected for 3' Long-Range PCR and Southern blot validation.

# Recombinant ES validation by Long Range PCR

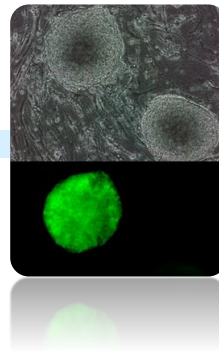

## Confirmation and Validation of candidate recombinant ES clones by 5' and 3' PCRs

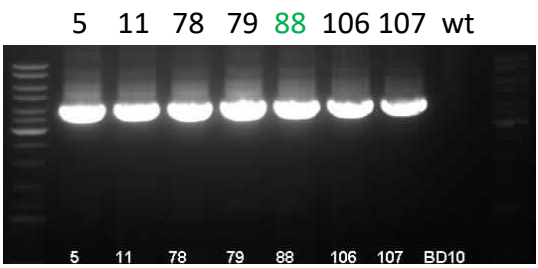
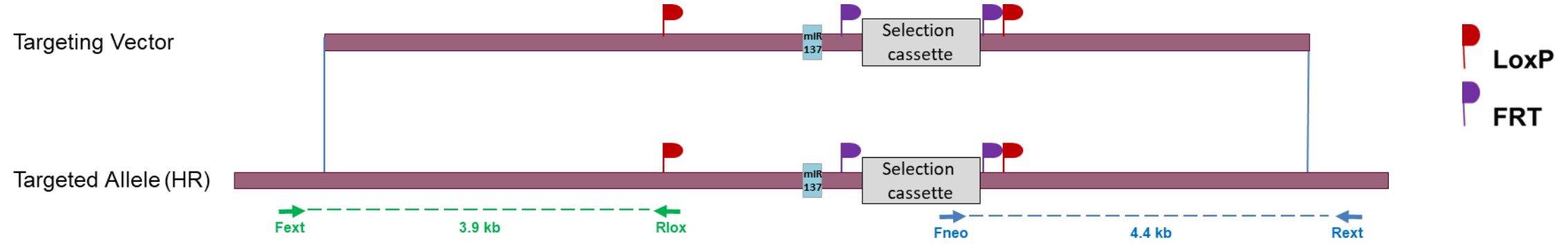

Pcr Fext – Rlox : 3.9 kb

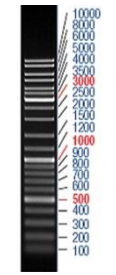

Ladder pattern

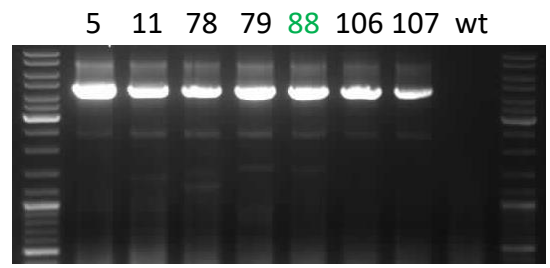

Pcr Fneo – Rext : 4.4 kb

Seven candidate clones identified by 5' PCR screening were further analysed by 3' PCR screening. Seven clones (clones #5, #11, #78, #79, #88, #106 and #107) were confirmed.

# Recombinant ES clones validation by Southern Blot – Internal probe

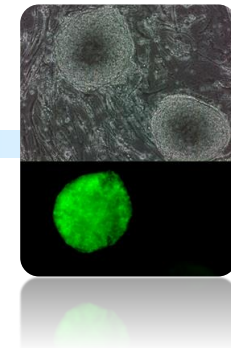

## Schematic Southern Blot validation strategy

Digests on the scheme illustrate the position of the chosen restriction sites relative to the probe. They don't show the exact position of the restriction sites.

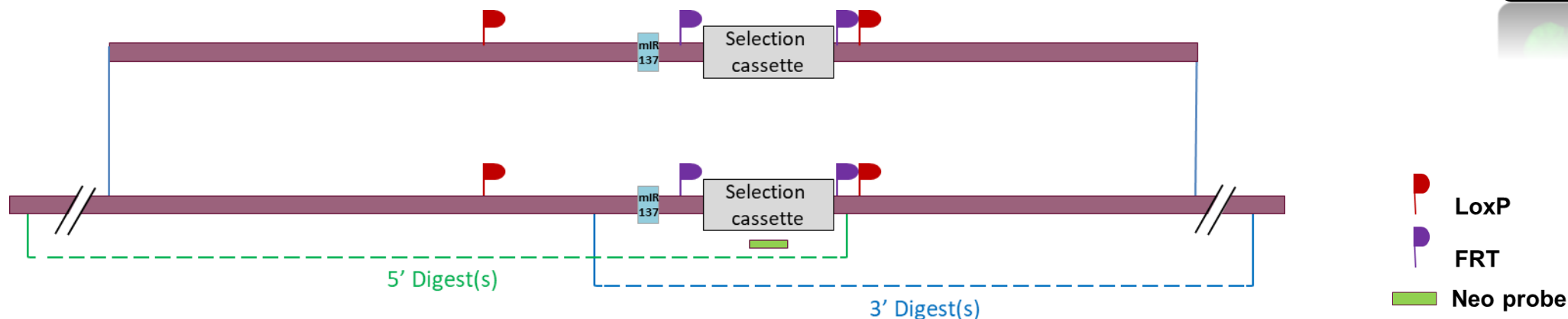

## Digestions used to validate the 5' and 3' insertion

Probe		Genomic DNA digest	Targeted Allele (kb)
Neo	5' digest		
	3' digest	AseI	7.8

### Southern blot - Neo 5'

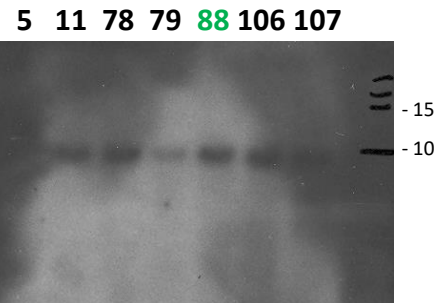

### Southern blot - Neo 3'

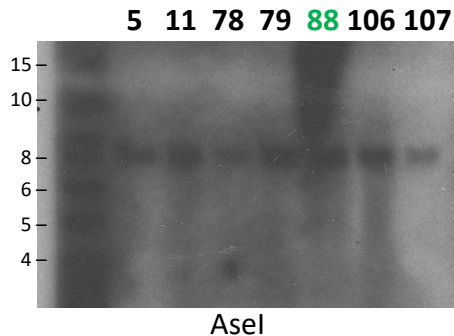

### Neo probe sequence

```

CTGCAGGACGAGGCAGCGCGGTATCGTGGCTGGCCACGACGGGCGTTCCCTTGCGCAGCTGTG
CTCGACGTTGTCACTGAAGCGGGAAGGGACTGGCTGCTATTGGGCGAAGTGCCGGGGCAGGAT
CTCCTGTCATCTCACCTTGCTCCTGCCGAGAAAGTATCCATCATGGCTGATGCAATGCGGCGG
CTGCATACGCTTGATCCGGCTACCTGCCCATTCGACCACCAAGCGAAACATCGCATCGAGCGA
GCACGTAICTGGATGGAAGCCGGTCTTGTGCGATCAGGATGATCTGGACGAAGAGCATCAGGGG
CTCGCGCCAGCCGAAGTTCGCCAGGCTCAAGGCGCGCATGCCCGACGGCGAGGATCTCGTC
GTGACCCATGGCGATGCCTGCTTGGCCGAATATCATGGTGGAAAATGGCCGCTTTTCTGGATTC
ATCGACTGTGGCCGGCTGGGTGTGGCGGACCGCTATCAGGACATAGCGTTGGCTACCCGTGAT
ATTGCTGAAGAGCTTGGCGGGAATGGGCTGACCGCTTCTCGTGTCTTACGGTATCGCCGCT
CCCATTGCGACGCGCATCGCCTTCTATCGCCTTCTTGACGAGTTCTTC
    
```



## ■ Aneuploidy screening in ES recombinant clones

Selected recombinant ES cells clones were karyotyped by Giemsa metaphase staining. Results of aneuploidy analysis are presented in the table below.

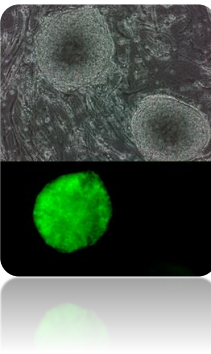

Clone ID	Giemsa
#5	Not done
<b>#11</b>	<b>Pass</b>
#78	Not done
#79	Failed
<b>#88</b>	<b>Pass</b>
#106	Not done
#107	Not done

# 5 MICROINJECTION & BREEDING



- Microinjection
- Breeding to F1 generation

## Microinjection



- The ES cells used in the injection experiment were originally derived from a C57BL/6N mouse strain (which have black coat colour). These cells were injected into blastocysts derived from an BALB/cN strain, which have a white coat colour. The resulting offspring are thus chimeras of two different cell types (ES cell-derived cells and host blastocyst-derived cells) and the degree of chimerism was monitored by the percentage of light and dark patches on these animals.
- Recipient blastocysts were isolated from mated BALB/cN females (Health status SPF Specific Pathogens Free).
- Recombinant ES clones #11 and #88 validated in previous project phase were injected into blastocysts to generate chimeric males. The results are presented in the table below.

Clone ID	Number of chimeric males identified according to chimerism rate (Number of chimeric males bred to F1 generation)			
	5 - 40%	45% - 55%	60-100%	Total
#11	1	2	2	5
#88	1	0	4	5

## ■ Breeding to F1 generation



- Four highly chimeric males generated in the previous phase by blastocyst injection of the ES clones were mated with wild-type C57BL/6NCrl females (health status SPF – Specific Pathogen Free) to investigate whether the recombined ES cells have contributed to the germ layer.
- Germ line transmission was obtained with clone #88 the 5/12/2012.
- The line issued from clone #88 was cryopreserved
- Allele nomenclature (following MGI guidelines) :**Mir37<sup>tm1.1lcs</sup>**





## REPORT REDACTION & VALIDATION

Report finalized on 2023/09/07

Prepared by Romain LORENTZ, IE

Verified and finalized by Marie-Christine BIRLING,  
PhD

## CONTACT US

By email at [mutagenesis@igbmc.fr](mailto:mutagenesis@igbmc.fr)

By phone at +33 (0)3 88 65 56 57

[www.phenomin.fr](http://www.phenomin.fr)